

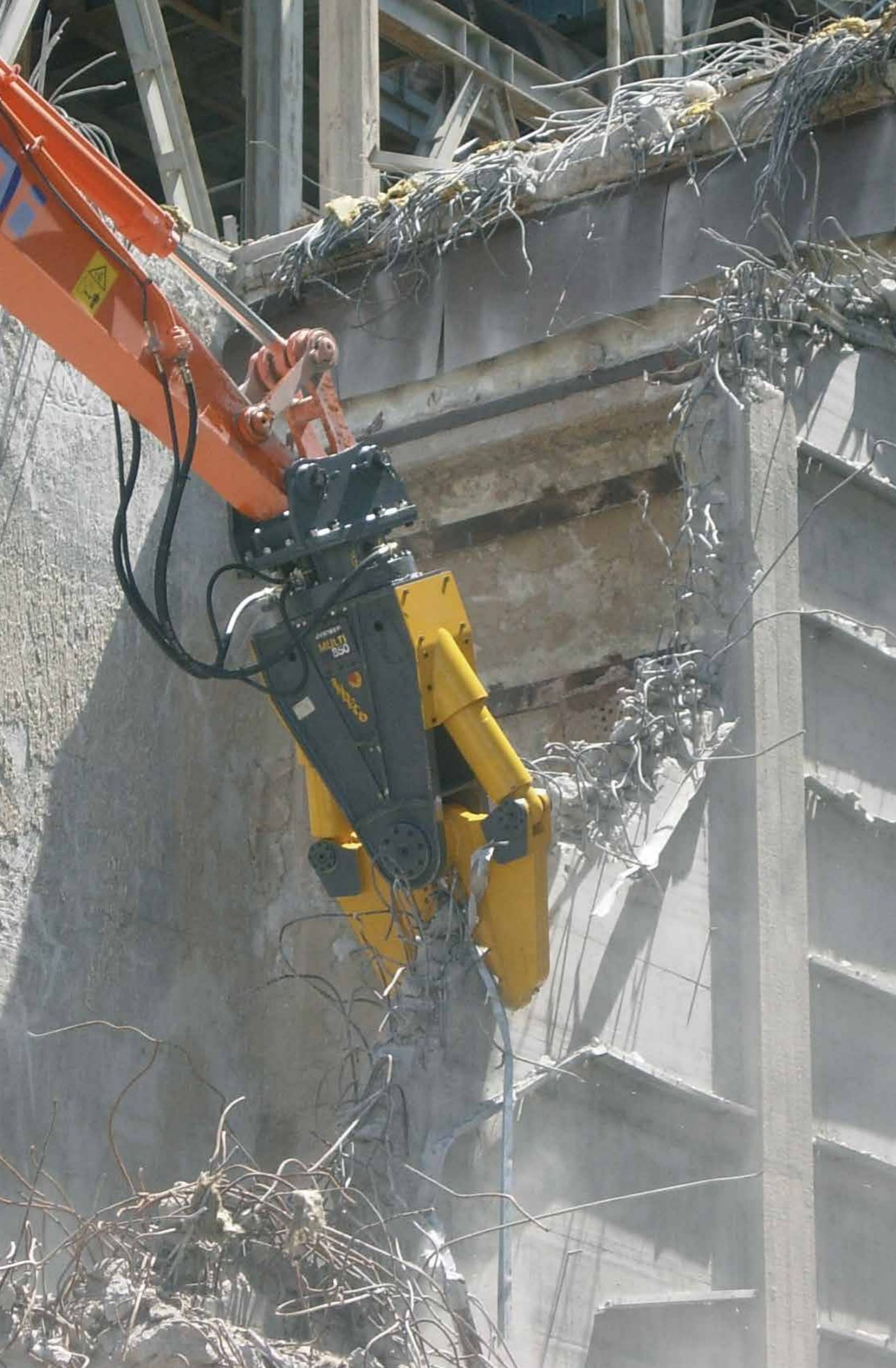



**Multiprocessor**

**IMP Series**





# application areas

		IMP	
 <p><b>Demolition &amp; renovation</b></p>	<b>Light Demolition</b>	<ul style="list-style-type: none"> <li>• Demolition of masonry structures <input type="radio"/></li> <li>• Brickwork <input type="radio"/></li> <li>• Natural stone <input type="radio"/></li> <li>• Renovation of interiors <input type="radio"/></li> <li>• Autoclaved aerated concrete <input type="radio"/></li> </ul>	
	<b>Demolition of non-reinforced concrete structures</b>	<ul style="list-style-type: none"> <li>• Primary demolition of lightweight and standard concrete <input type="radio"/></li> <li>• Primary demolition of heavyweight concrete <input type="radio"/></li> <li>• Wall elements <input type="radio"/></li> <li>• Secondary demolition <input type="radio"/></li> </ul>	
	<b>Composite steel &amp; concrete structure demolition</b>	<ul style="list-style-type: none"> <li>• Primary Demolition of Lightweight and Standard reinforced concrete <input type="radio"/></li> <li>• Primary demolition of heavyweight steel - reinforced concrete <input type="radio"/></li> <li>• Secondary Demolition floors, slabs and beams <input type="radio"/></li> <li>• Separating rebars from pillars and struts <input type="radio"/></li> <li>• Fiber-reinforced concrete <input type="radio"/></li> <li>• Cutting rebars and steel reinforcements <input type="radio"/></li> </ul>	
	<b>Demolition of metallic buildings and structures</b>	<ul style="list-style-type: none"> <li>• Demolition of refineries <input type="radio"/></li> <li>• Cutting of Metal and steel structures <input type="radio"/></li> <li>• Cutting steel girders/beams <input type="radio"/></li> <li>• Cutting reinforcements <input type="radio"/></li> </ul>	
	<b>Sorting and Loading</b>	<ul style="list-style-type: none"> <li>• Sorting</li> <li>• Loading</li> <li>• Waste handling</li> <li>• Site clean-up</li> </ul>	
	<b>Pavement demolition</b>	<ul style="list-style-type: none"> <li>• Asphalt <input type="radio"/></li> <li>• Concrete <input type="radio"/></li> <li>• Composite surfaces <input type="radio"/></li> </ul>	
	 <p><b>Recycling</b></p>	<b>Processing</b>	<ul style="list-style-type: none"> <li>• Scrap material processing</li> <li>• Cutting tyres</li> <li>• Processing rail cars</li> <li>• Processing cars, trucks and general automotive</li> <li>• Cutting tanks</li> </ul>
		<b>Handling and sorting</b>	<ul style="list-style-type: none"> <li>• Scrap material handling</li> <li>• Scrap material sorting</li> <li>• Urban waste</li> <li>• Industrial waste</li> <li>• Wood and tyres</li> </ul>
		<b>Downsizing and sorting</b>	<ul style="list-style-type: none"> <li>• Material downsizing and sorting in recycling quarries <input type="radio"/></li> </ul>



# Multiprocessor Indeco IMP

Designed to ensure maximum versatility, the Indeco IMP multiprocessor is the perfect solution for specialist or non-specialist firms who need a tool that can handle a variety of different jobsite situations in the demolition and recycling field. Different jawsets enable it to be used in the various breaker, pulverizer and shear configurations on the same carrier.

Made with the latest technologically advanced materials, such as special extra-strength HARDOX® steel alloys, which eliminates any flexing of the body, the Indeco IMP multiprocessor is designed to withstand high levels of pressure, wear and abrasion, and prolonged use regardless of jobsite conditions. Unique features such as the special design of the jaws, the tried and tested rotation mechanism (found on all Indeco rotating products) and interchangeable teeth on the mobile jaw in pulverizer configuration, help this product perform very well in all applications.

In “shear” configuration, some of the unique features of the Indeco ISS shears have been incorporated, such as the cutting geometries, the blade configurations, and the exclusive piercing system.

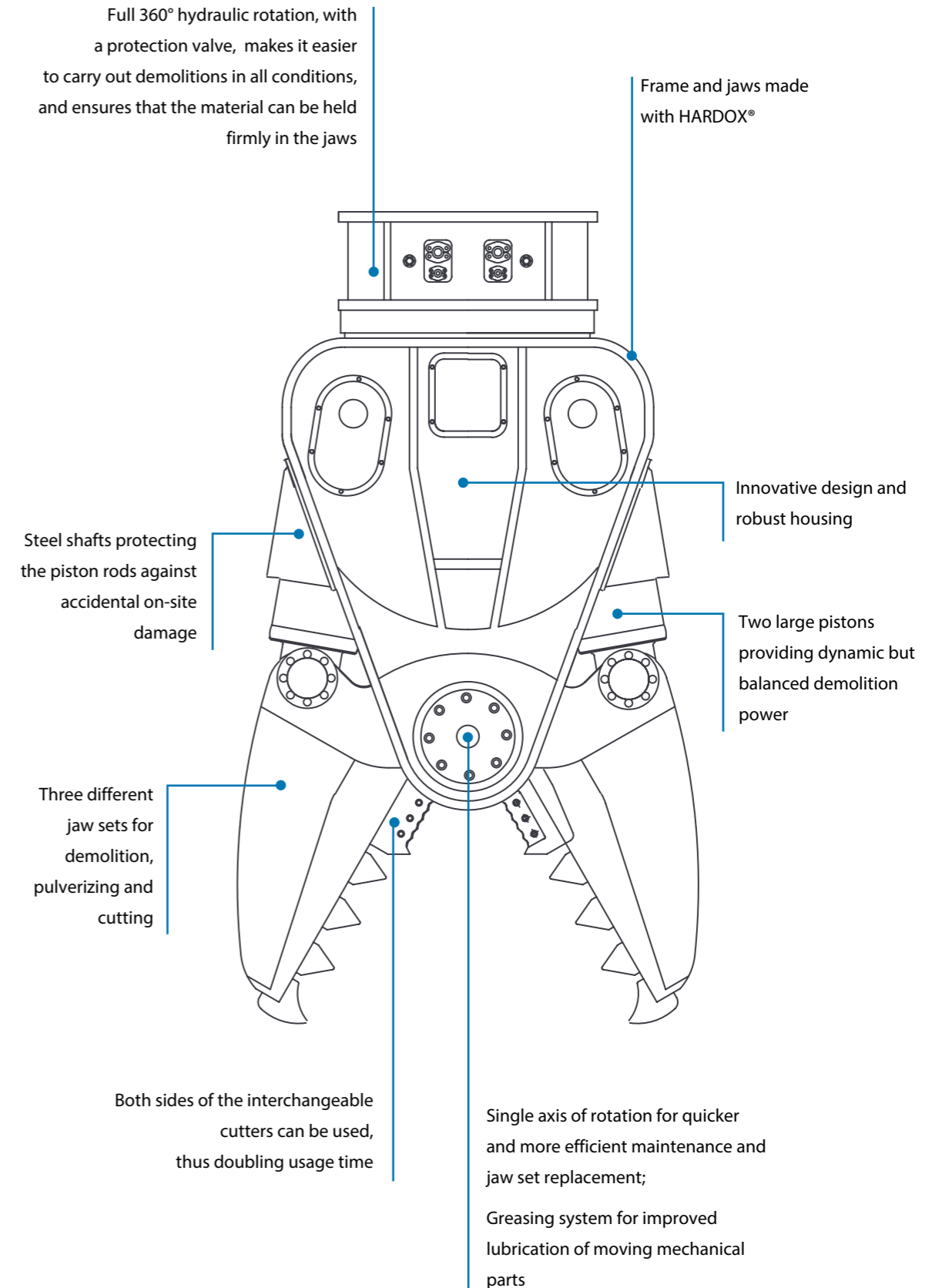



Technical Data	IMP 15	IMP 20	IMP 25
Type of carrier	4 5	4 5	4 5
Excavator weight*	12 ÷ 24 tons	17 ÷ 36 tons	20 ÷ 45 tons
Width	425 mm	475 mm	495 mm
Oil delivery	150 ÷ 250 l/min	180 ÷ 250 l/min	200 ÷ 300 l/min
Maximum pressure at cylinders	350 bars	400 bars	400 bars
Closure time (no-load)	2 s	2,5 s	3 s
Opening time (no-load)	1 s	1,2 s	1,5 s
Hydraulic connections for cylinders	3/4"	3/4"	3/4"
Maximum rotation flow	20 l/min	25 l/min	25 l/min
Maximum rotation pressure	110 bars	110 bars	110 bars
Hydraulic connections for rotation	1/2"	1/2"	1/2"
Mounting bracket compatibility	HP 2000 - HP 2500	HP 3000 ÷ HP 4000	HP 3000 ÷ HP 4000

\*The operating weight of the equipment includes mounting bracket compatible with Indeco construction standards. Any differences in weight may be due to a different mounting bracket configuration.



Technical Data	IMP 35	IMP 45
Type of carrier	5	5
Excavator weight*	28 ÷ 55 tons	38 ÷ 65 tons
Width	590 mm	640 mm
Oil delivery	220 ÷ 320 l/min	270 ÷ 370 l/min
Maximum pressure at cylinders	400 bars	400 bars
Closure time (no-load)	4 s	4 s
Opening time (no-load)	2 s	2 s
Hydraulic connections for cylinders	1"	1"
Maximum rotation flow	30 l/min	30 l/min
Maximum rotation pressure	110 bars	110 bars
Hydraulic connections for rotation	1/2"	1/2"
Mounting bracket compatibility	HP 5000	HP 7000 - HP 9000

N.B. All illustrations and numerical data in this catalog are purely indicative and subject to change at our discretion and without notice. We therefore reserve the right to modify them with a view to improving and continuously developing our product.

### Carrier key



### compatibility

Suggested uses on machines with an overall weight (in tons):

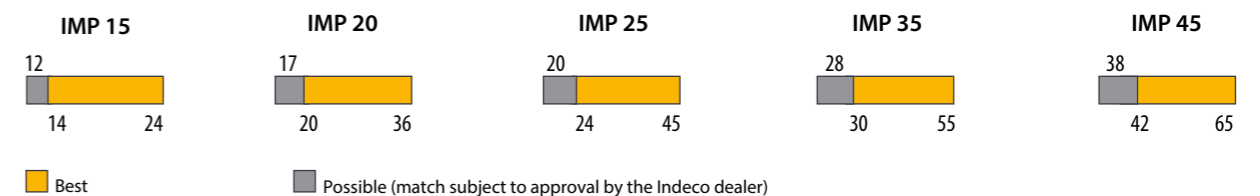

# jaw technical data

Jaws for IMP 15	Crusher	Pulverizer	Shear
Operating weight*	1500 Kg	1500 Kg	1600 Kg
Height	1900 mm	1856 mm	1950 mm
Maximum opening	815 mm	717 mm	450 mm
Jaw depth	595 mm	574 mm	500 mm
Cutter blade length	180 mm	180 mm	180 mm
Max clamping force at tip	50 tons	50 tons	55 tons
Maximum clamping force at shears	230 tons	225 tons	220 tons

Jaws for IMP 20	Crusher	Pulverizer	Shear
Operating weight*	2080 Kg	2080 Kg	2200 Kg
Height	2120 mm	2070 mm	2170 mm
Maximum opening	910 mm	800 mm	500 mm
Jaw depth	660 mm	640 mm	550 mm
Cutter blade length	180 mm	180 mm	540 mm
Max clamping force at tip	60 tons	65 tons	70 tons
Maximum clamping force at shears	270 tons	280 tons	270 tons

Jaws for IMP 25	Crusher	Pulverizer	Shear
Operating weight*	2400 Kg	2450 Kg	2600 Kg
Height	2290 mm	2280 mm	2340 mm
Maximum opening	1050 mm	850 mm	550 mm
Jaw depth	760 mm	700 mm	620 mm
Cutter blade length	180 mm	180 mm	600 mm
Max clamping force at tip	95 tons	90 tons	90 tons
Maximum clamping force at shears	340 tons	340 tons	330 tons

Jaws for IMP 35	Crusher	Pulverizer	Shear
Operating weight*	3500 Kg	3600 Kg	3700 Kg
Height	2450 mm	2500 mm	2515 mm
Maximum opening	1150 mm	1050 mm	640 mm
Jaw depth	860 mm	870 mm	710 mm
Cutter blade length	180 mm	180 mm	180 mm
Max clamping force at tip	110 tons	110 tons	120 tons
Maximum clamping force at shears	390 tons	430 tons	420 tons

Jaws for IMP 45	Crusher	Pulverizer	Shear
Operating weight*	4500 Kg	4700 Kg	4900 Kg
Height	2660 mm	2730 mm	2760 mm
Maximum opening	1250 mm	1150 mm	700 mm
Jaw depth	930 mm	950 mm	780 mm
Cutter blade length	180 mm	180 mm	720 mm
Max clamping force at tip	130 tons	130 tons	140 tons
Maximum clamping force at shears	460 tons	480 tons	460 tons

\*The operating weight of the equipment includes mounting bracket compatible with Indeco construction standards. Any differences in weight may be due to a different mounting bracket configuration.

## IMP - crusher configuration

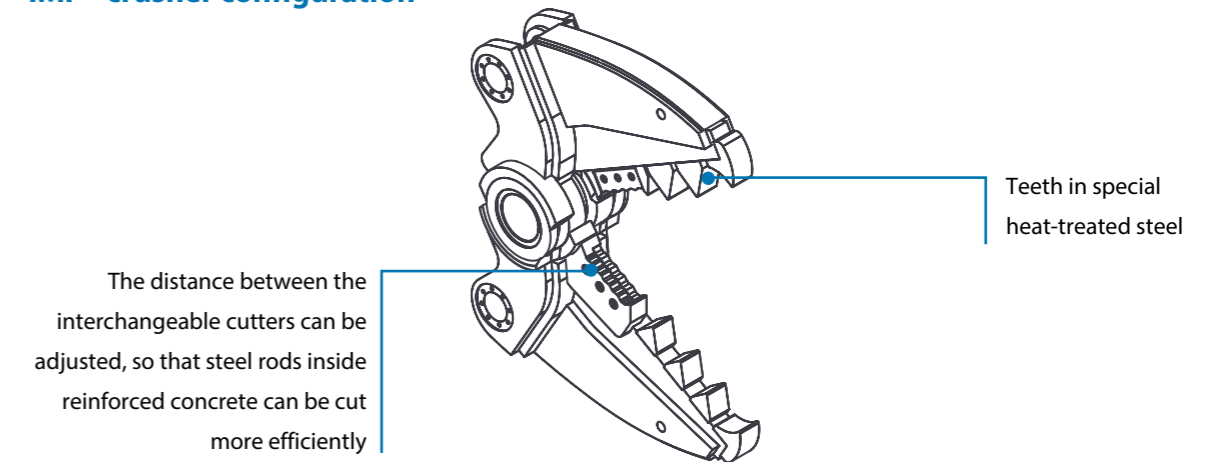

## IMP - pulverizer configuration

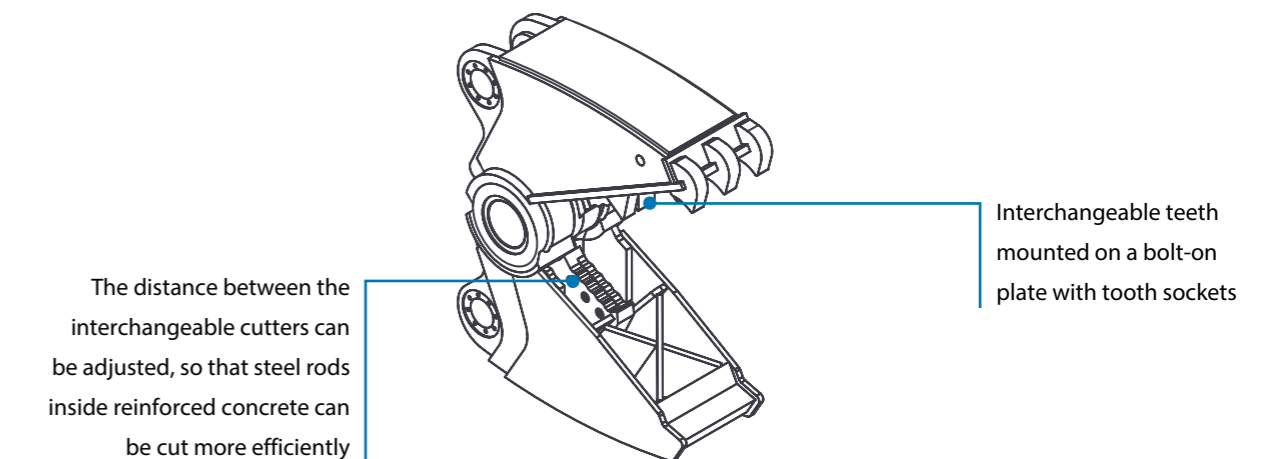

## IMP - shear configuration

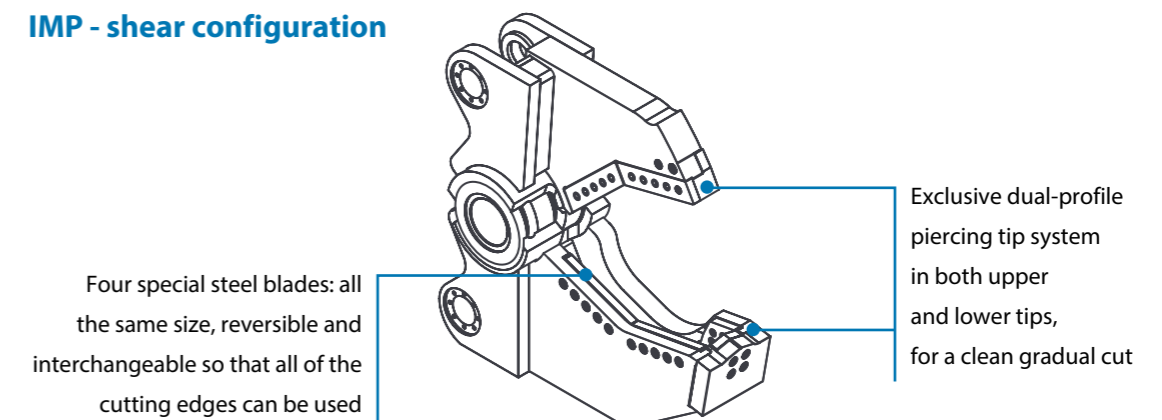

















# Appetite guide

Profiles and maximum dimensions that can be cut with the IMP in "Shear" configuration







## Shear for IMP 15

Type	UNI	Type	UNI
	UPN 100		HEA 100
	90x90x8		min. 200x6 mm max 120x10 mm
	88,9x7,1		40 mm
	IPE 120		







## Shear for IMP 20

Type	UNI	Type	UNI
	UPN 120		HEA 100
	110x110x10		min. 230x6 mm max 140x10 mm
	101,6x6,3		45 mm
	IPE 140		







## Shear for IMP 25

Type	UNI	Type	UNI
	UPN 160		HEA 120
	120x120x12		min. 450x6 mm max 180x10 mm
	114,3x8		50 mm
	IPE 180		

## Shear for IMP 35

Type	UNI	Type	UNI
	UPN 180		HEA 140
	130x130x12		min. 520x6 mm max 260x12 mm
	121x10		55 mm
	IPE 200		

## Shear for IMP 45

Type	UNI	Type	UNI
	UPN 200		HEA 160
	150x150x12		min. 580x6 mm max 230x15 mm
	139,7x8		60 mm
	IPE 220		

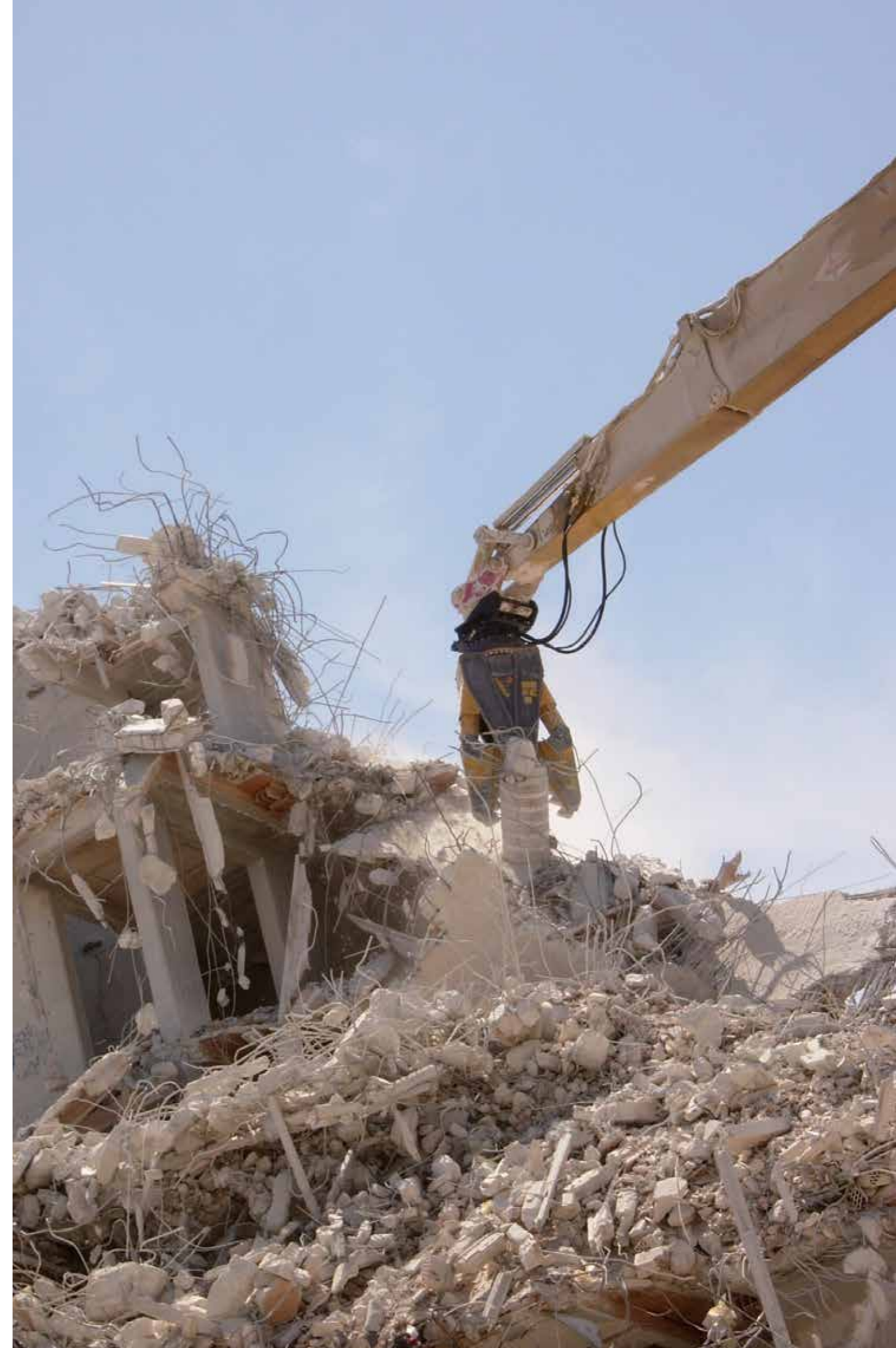

## The full range of other Indeco products

Products		Weight		Products		Weight	
IFP	8 X	750	Kg	IHC	150	970	Kg
IFP	13 X	1300	Kg	IHC	250	1280	Kg
IFP	19 X	1800	Kg	IHC R	50	425	Kg
IFP	28 X	2800	Kg	IHC R	70	630	Kg
IFP	35 X	3450	Kg	IHC R	75	670	Kg
IFP	45 X	4400	Kg	IHC R	150	1185	Kg
IRP	11 X	1150	Kg	IHC R	250	1520	Kg
IRP	18 X	1700	Kg	IMG S**	400	380	Kg
IRP	23 X	2300	Kg	IMG S**	600	570	Kg
IRP	29 X	2950	Kg	IMG S**	1200	1140	Kg
IRP	36 X	3600	Kg	IMG S**	1700	1610	Kg
IRP	45 X	4500	Kg	IMG S**	2300	2180	Kg
IMP*	15	1500	Kg	IMG S**	2800	2650	Kg
IMP*	20	2080	Kg	ISS***	10/20	2400	Kg
IMP*	25	2400	Kg	ISS***	20/30	3650	Kg
IMP*	35	3500	Kg	ISS***	25/40	4800	Kg
IMP*	45	4500	Kg	ISS***	30/50	6100	Kg
IHC	50	200	Kg	ISS***	35/60	7800	Kg
IHC	70	445	Kg	ISS***	45/90	10400	Kg
IHC	75	485	Kg				

\*Crusher configuration - \*\*Sorter configuration - \*\*\*Third-member configuration

Indeco Ind. SpA  
viale Lindemann, 10 z.i. - 70132 Bari - Italy  
tel. +39 080 531 33 70 - fax +39 080 537 79 76



info@indec.it - www.indec.it

The contents of this publication may not be reproduced in whole or in part without prior authorization from the Indeco Ind. SpA. All rights reserved.

Trademarks used in this catalog are the property of their respective holders.



Unione Europea



Governo Italiano



REGIONE PUGLIA



PO FESR  
PUGLIA  
2007 - 2013

PUGLIA EUROPA  
Investiamo nel vostro futuro.

Intervention co-financed by the EU under ERDF Puglia 2007/2013, Action 6.3.3. "Support for the international promotion of PMIs in Puglia"